

Cook & Hold Oven

Model 1200-SK

Smoker Ovens effortlessly infuse bold flavors with real wood chips. No pressure-cooking or artificial smoke flavor required.

Gentle, low and slow Halo Heat® technology evenly surrounds food without the use of extremely hot elements, added humidity or fans. This controlled, uniform heat maintains precise temperatures throughout the hot smoking, cooking and holding process—improving food quality and extending hold times.

Cook by time or probe with simple or deluxe controls. Probes sense internal product temperature and automatically convert the oven from cook mode to hold mode once set parameters have been reached.

Labor-free, overnight smoking, cooking and holding paired with effortless operation reduces labor costs and increases productivity.

Advanced controls – designed intentionally simple – feature an intuitive, user-friendly interface and programmable recipes to ensure consistency with each cook.

ChefLinc™, cloud-based remote oven management software, streamlines processes and maximizes profits with data-driven insights (deluxe control only).

ISO 9001:2015-certified.

Standard Features

- Casters (two [2] rigid, two [2] swivel with brake)
- Two [2] single-point, straight removable probe
- Drip tray and drip pan with drain
- Programmable, touchscreen control on Deluxe model
- Programmable control on Simple model
- HACCP data collection on Deluxe model
- Easy recipe upload/download via USB port
- SureTemp™ heat recovery on Deluxe model
- Two [2] stainless steel side racks with fifteen [15] pan positions spaced 1-7/16" [37mm] on centers
- Removable exterior drip tray
- Woodchip tray and sample bag of woodchips



7

Full-size pans — 20" x 12" x 2-1/2" per cavity, on wire shelves only
GN 1/1 — 530mm x 325mm x 65mm

14

Half-size pans — 10" x 12" x 2-1/2" per cavity, on wire shelves only
GN 1/2 — 265mm x 325mm x 65mm

Maximum weight per cavity: 120 lbs. [54 kg]
Volume maximum per cavity: 60 quarts [56.8 liters]

Four [4] shelves and two [2] rib racks included.
Additional shelves required for maximum capacity.

CAPACITY
per Cavity



On all Cook & Hold heating elements [excludes labor]

ALTO-SHAAM



Shown with Deluxe control

1200-SK



Shown with Simple control

Configurations (select one each)

Models

- Simple
 - HACCP option
- Deluxe
 - Ethernet option [5032090]

Door Choice

- Right hinged, solid door, standard
- Right hinged, window door
- Left hinged, solid door
- Left hinged, window door

Electrical

- 208-240V, 1Ph

Casters and Legs

- 3-1/2" [89mm] casters, two [2] rigid two [2] swivel with brake, standard [5027133]
- 5" [127mm] casters, two [2] rigid two [2] swivel with brake, option, [5027112]
- 6" [152mm] legs, set of four [4] [5032092]
- 6" [152mm] seismic legs, set of four [4] [5032093]

Optional Accessories (select all that apply)

Bumper and Handles

- Full perimeter bumper
- Push/Pull handle kit

Additional Probes

- Sous vide probe [PR-36576]
- T-handle probe, up to six [6] with Deluxe per cavity [PR-46998]
- Straight probe, up to six [6] with Deluxe per cavity [qty two [2] included with oven] [PR-46999]

Drip Pans, Shelves, Holders

- Drip pan with drain [5025893]
- Drip pan, without drain [1034371]
- Increased capacity exterior drip pan [5030659]
- Shelf, stainless steel [SH-2325]
- Carving holder, prime rib [HL-2635]
- Carving holder, steamship [cafeteria round] [4459]

Cleaners

- Alto-Shaam, non-caustic cleaner one [1] 32-ounce bottle [CE-46828]
- Alto-Shaam, non-caustic cleaner six [6] 32-ounce bottles [CE-46829]

Accessories, misc.

- Door lock with key [5028755]

Woodchips, 2.0 lb [0.9 kg] bag

- Cherry [WC-22540]
- Maple [WC-22544]
- Apple [WC-22542]
- Hickory [WC-2828]

Cook & Hold Oven

Model 1200-SK

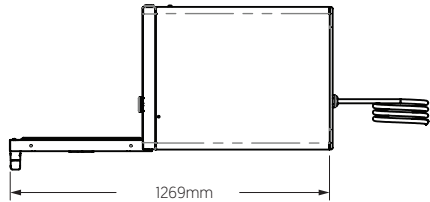
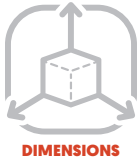

OVERALL HEIGHT: 1200-SK		
Accessory	in	mm
5" caster	71-3/4"	1821
3-1/2" caster	70-11/16"	1795
6" leg (min)	69-5/8"	1767
6" leg (max)	71-7/8"	1824
6" seismic leg (min)	70-9/16"	1791
6" seismic leg (max)	73"	1853

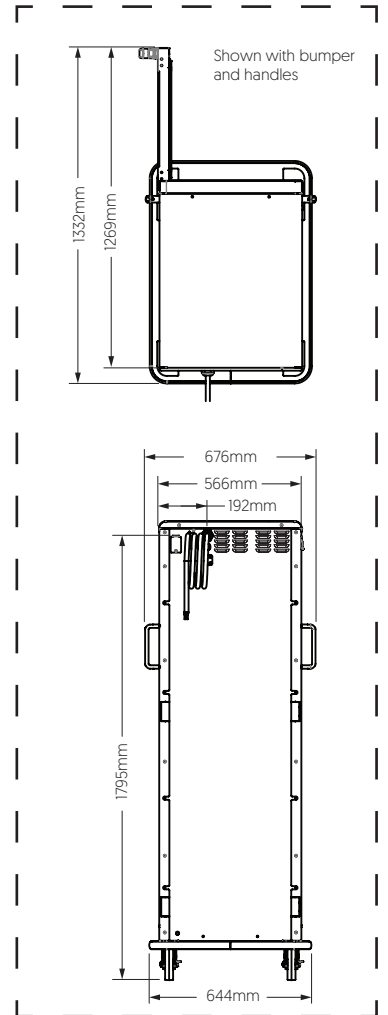

Shown with Simple control and 3-1/2" casters

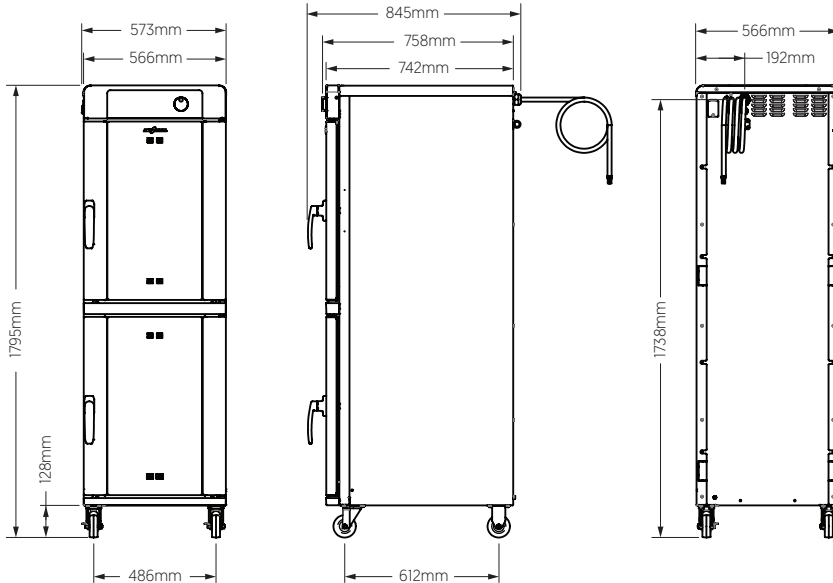

Interior (H x W x D) Per Cavity	Net Weight	Ship Dimensions (L x W x H)	Ship Weight
26-7/8" x 18-7/8" x 26-1/2" [683mm x 479mm x 673mm]	450 lbs. [204 kg]	39" x 39" x 78" [991mm x 991mm x 1372mm]	515 lbs. [234 kg]



- Top: 2" [51mm]
- Left: 2" [51mm]
- Right: 2" [51mm]
- Back: 3" [76mm]



The oven must be installed level.
The oven must not be installed in any area where it may be affected by steam, grease, dripping water, high temperatures, or any other severely adverse conditions.

See local installation codes for smoker ventilation requirements.

Cook & Hold Oven

Model 1200-SK



HEAT

Heat of rejection

1200-SK	Heat Gain qs, BTU/hr	Heat Gain qs, kW
	1,662	0.49



TEMPERATURE

Cooking temperature range:

200°F–325°F [94°C–163°C]

Holding temperature range:

85°F–205°F [29°C–96°C]



ELECTRIC

1200-SK Smoker

1200-SK	V	Ph	Hz	Awg	IEC	A	Breaker (A)	kW	Plug Configuration	Certification
208–240V**	208	1	60	8	—	33	50	6.9	Alto-Shaam offers a number of readily available cord and plug configurations. Contact factory for options.	
	240	1	60	8	—	37	50	8.9		
230V	230	1	50/60	8	—	36	50	8.3		
	230	1	50/60	8	—	25	32	5.7*		
380-415V	380	3	50/60	10	2.5	20	25	7.7		
	415	3	50/60	10	2.5	22	32	8.9		

Electrical connections must meet all applicable federal, state, and local codes.

*Reduced wattage configuration.

** Dedicated circuit required.

CONTACT US

W164 N9221 Water Street | Menomonee Falls, Wisconsin 53051 | U.S.A.
 Phone: 262.251.3800 | 800.558.8744 U.S.A./Canada | Fax: 262.251.7067 | alto-shaam.com